

NOTES:
 1. MECHANICAL: MATING FORCE: 5-20N .
 UNMATING FORCE: 8-20N .
 DURABILITY: 10000 CYCLES MIN.
 2. ELECTRICAL:
 CURRENT: 5.0A MAX
 VOLTAGE: 20V MAX
 WITHSTANDING VOLTAGE: 100V AC
 CONTACT RESISTANCE: 40 mΩ MAX INITIAL;
 50 mΩ MAX AFTER 10000 CYCLES
 3. ENVIRONMENTAL:
 OPERATING TEMPERATURE RANGE -30° C ~ +80° C
 4. Salt Spray: 24H

BOM			
序号	名称	用量	品名规格
1	外壳	1	Typec 16PIN 沉板 1.6 外壳 SUS304 T=0.30mm
2	Molding 3	1	Typec 16PIN 沉板 1.6 Molding C7025 T=0.15 PA9T黑色 半成品
2.1	Molding 1	1	Typec 16PIN 沉板 1.6 Molding A C7025 PA9T黑色
2.2	Molding 2	1	Typec 16PIN 沉板 1.6 Molding B C7025 PA9T黑色
2.3	卡勾	1	Typec 16PIN 沉板 卡勾 SUS301 T=0.15mm

料号编码:

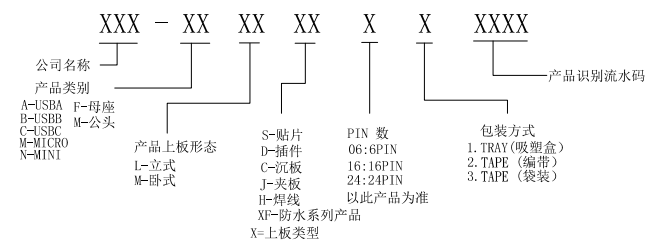

A1	GND	B12	GND
A2		B11	
A3		B10	
A4	VBUS	B9	VBUS
A5	CC1	B8	SBU2
A6	D+	B7	D-
A7	D-	B6	D+
A8	SBU1	B5	CC2
A9	VBUS	B4	VBUS
A10		B3	
A11		B2	
A12	GND	B1	GND

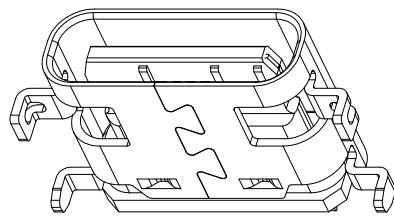

ZDX 深圳市兆达鑫科技有限公司
 Shenzhen zhaodaxin Technology Co., Ltd

TITLE:		PART NO.: ZDX-CFMS162JC04		
Type-C 16PIN 沉板1.6 L=6.5mm		TEL: 0755-29888153		
工程图		WEB: http://www.szddjmkj.com/		
THIRD ANGLE PROJECTION	UNIT:	SCALE:	SIZE:	SHEET:
	mm	1:1	A4	1/2

RoHS Compliant

Halogen Free

customer drawing

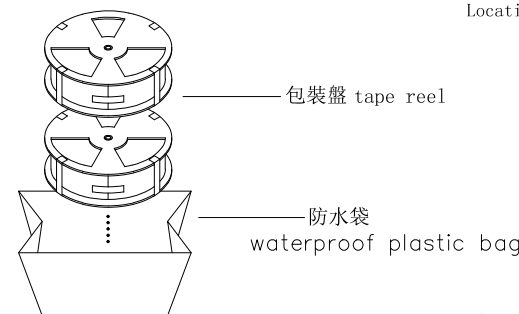
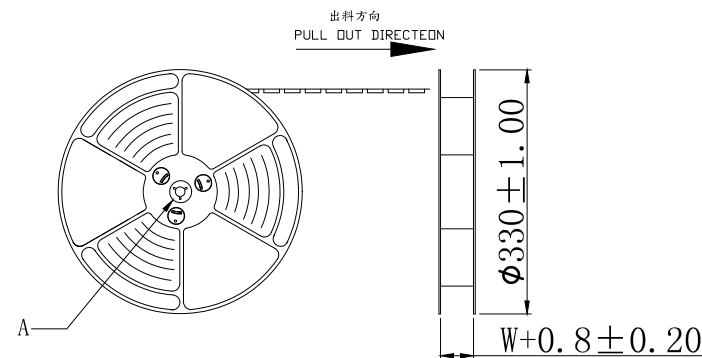

at small positioning hole of the carrier tape side).
標簽黏貼處 (朝捲裝包材的小定位孔一側)
Location of label sticking (label)

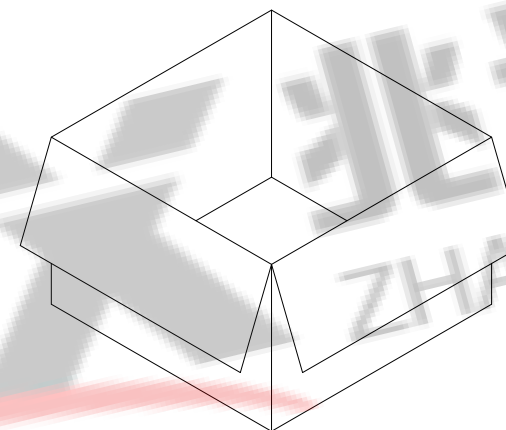
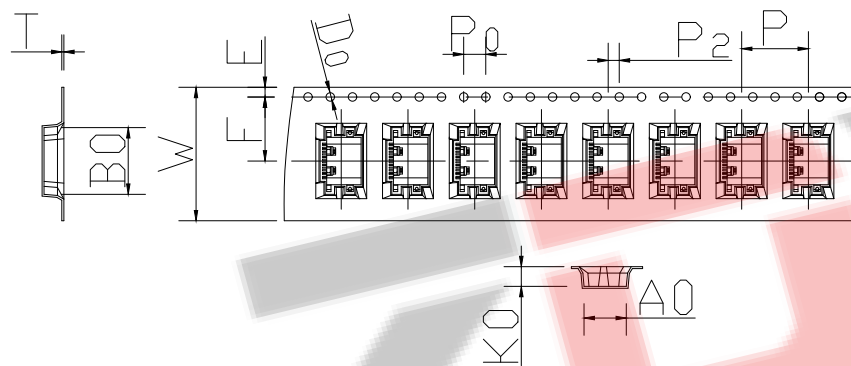
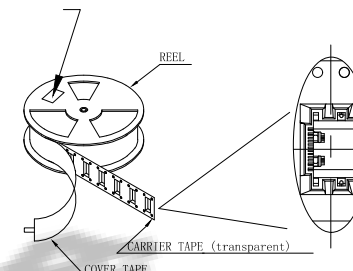

紙箱: 340mmX340mmX325mm

NOTE:

1. 每捲包裝數量及每箱裝箱數量如左下表格。
Packing q'ty of each reel & carton as below table shown.
2. 將裝滿產品的卷盤放入紙箱並以膠帶封口。
Put reels in the carton and use adhesive tape to seal up.

NOTES

1. 帶子引導長度
LEAD TAPE LENGTH
出料方向
PULL OUT DIRECTEON

2. 上帶 剝力力為: 0.1~1.3N(10.2gf~130gf)
PEELING OFF FORCE OF TOP TAPE: 0.1~1.3N(10.2gf~130gf)
出貨'運輸過程中一定注意:
THIS REQUIREMENT SHOULD BE APPLIED AT SHIPMENT;
卷帶在運輸過程中不能散開
PEELING OFF SHOULD NOT BE ALLOWED DURING TRANSPORTATION

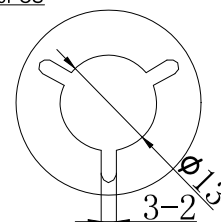
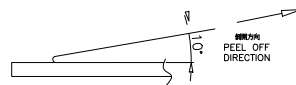

DETAIL: A
10:1

W	24.00±0.3
A0	7.6±0.1
B0	12.0±0.1
K0	3.55±0.1
P	12.00±0.1
F	11.50±0.1
E	1.75±0.1
D0	1.50±0.1
P0	4.00±0.1
P2	2.00±0.1
T	0.35±0.1

卷帶	規格: $\phi 330\text{mm}$	包裝數量: 10000PCS
紙箱	規格: 340mmX340mmX325mm	包裝數量: 10盤(10000PCS)

ZDX 深圳市兆達鑫科技有限公司
Shenzhen zhaodaxin Technology Co., Ltd

TITLE: Type-C 16PIN 沉板 包裝規範 工程圖		PART NO.: ZDX-CFMS162JC04		
		TEL: 0755-29888153		
		WEB: http://www.szddjmkj.com/		
THIRD ANGLE PROJECTION	UNIT: mm	SCALE: 1:1	SIZE: A4	SHEET: 1/2