

RoHS Compliant

Halogen Free

customer drawing

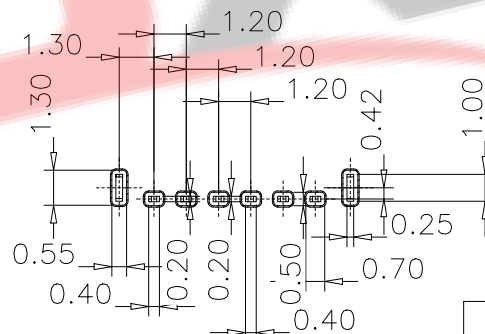
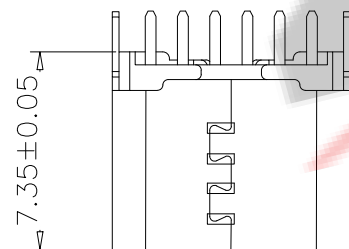
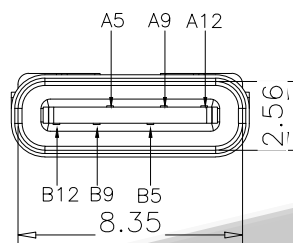
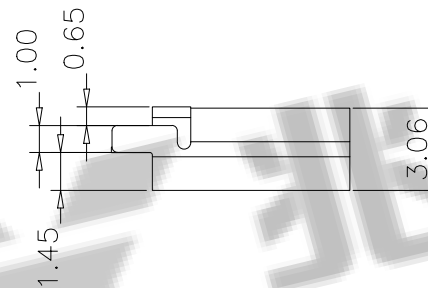
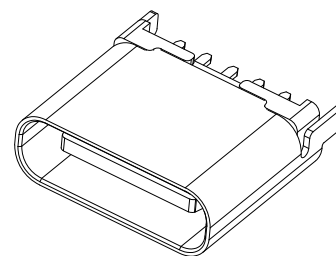
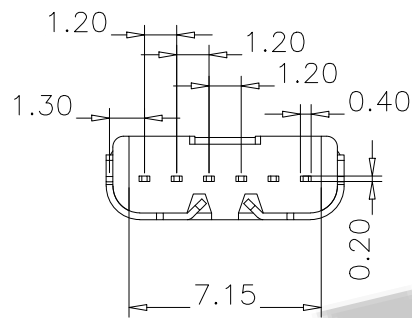
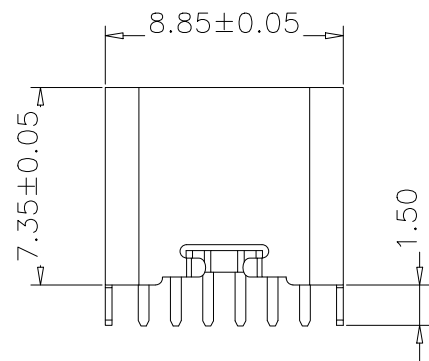

RECOMMEND P.C.B LAYOUT (COMPONENT SIDE)
TOLERANCE FOR PCB LAYOUT IS ±0.05

USB TYPE C PIN ASSIGNMENTS

PIN NUMBER	SIGNAL NAME	PIN NUMBER	SIGNAL NAME
		B12	GND
		B9	VBUS
A5	CC1		
		B5	CC2
A9	VBUS		
A12	GND		

TABLE:

NO	PART	Q'TY	Material
1	SHELL	1	ZINC ALLOY, NI30u"Min PLATED
2	CONTACT	6	C2680, TIN80u"/Au1u"/NI30u" PLATED
3	IMD HOUSING	1	LCP UL94 V-0 BLACK

备注 (NOTE):

1 材质:

1.1 胶芯: LCP UL94 V-0

1.2 端子: C2680, T=0.2mm; 镍底, 镀金

1.3 外壳: SUS201/304 表面镀镍

2 电气特性:

2.1 接触区: 接触电阻 40mΩ Max, 允许 10mΩ 变化量. 测试条件: 20mv, 100mA 下测量.

2.2 接触电流: 3A VBUS 引脚; 1.25A 用于 GND 引脚; 其他引脚为 0.25A.

2.3 额定电压: 5V.

2.4 耐电电压: 100VAC.

2.5 绝缘电阻: 至少 100 兆欧.

3 机械性能:

3.1 插入力: 0.5-2.0Kg

3.2 拔出力: 0.6-2.04Kg

3.3 插拔次数: 10000 次.

4 工作环境: -20°C to +85°C.

5 耐焊接热: 端子浸入 250±5°C 的锡槽中; 历时 3-5S±0.5Sec, 沾锡面积 95% 以上

6 外观: 部件可以承受以下焊接条件: 温度 250°C, 时间 8-10 秒, 外观无损坏变形

7 包装: 盒装, 1000pcs 一盒 编带, 1000pcs 一盘

料号编码:

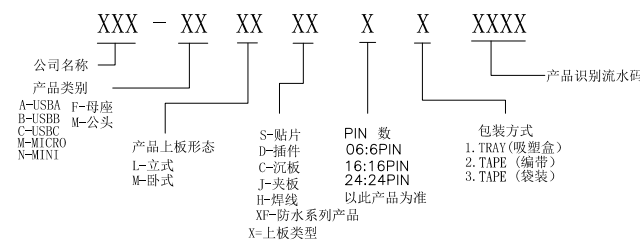

ZDX 深圳市兆达鑫科技有限公司
Shenzhen zhaodaxin Technology Co., Ltd

TITLE:		PART NO.: ZDX-CFLD061ZH12		
TYPE-C6P 直插 7.35 1.5脚		TEL: 0755-29888153		
工程图		WEB: http://www.szzdjmkj.com/		
THIRD ANGLE PROJECTION	UNIT:	SCALE:	SIZE:	SHEET:
	mm	1:1	A4	1/2