

RoHS Compliant

Halogen Free

customer drawing

电气特性:Electrical:

1. 额定电流: 3A MIN ROR VBUS
0.25A MIN FOR OTHER
2. 接触阻抗: 40 milliohms MAX
3. 绝缘阻抗: 100MEGA ohms MIN
4. 耐压测试: 250V AC
5. 插拔力: Mate force: 2.0kgf (MAX)
Unmate force: 0.8kgf (MIN)
6. 使用寿命: 10000次
7. 工作温度: -55 °C ~ 85 °C

原材料:Material:

1. 塑胶: LCP+30%G.F UL94V-0
2. 端子: Copper Alloy C5191
3. 外壳: 不锈钢 T=0.30mm

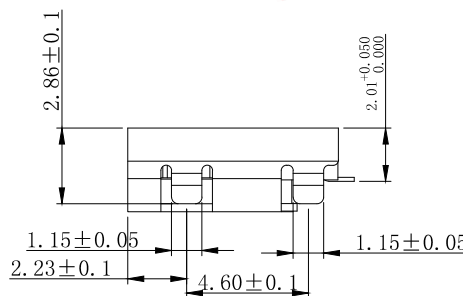
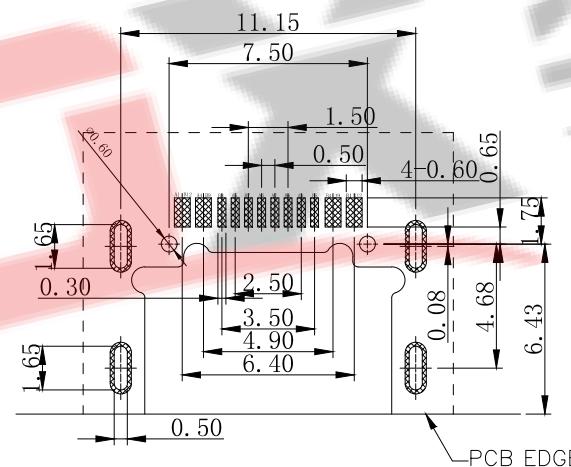
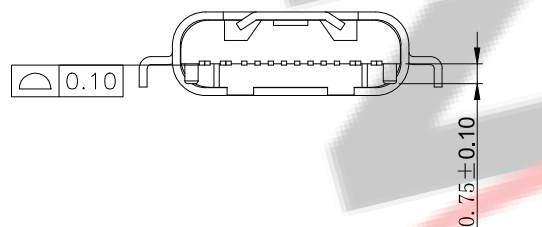
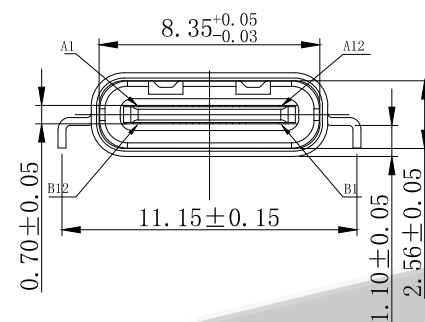
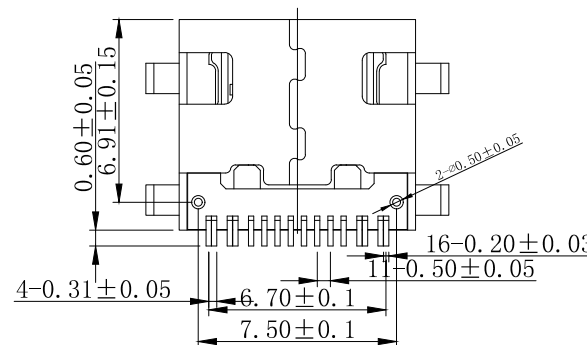
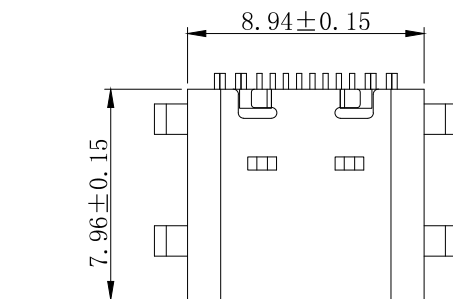

料号编码:

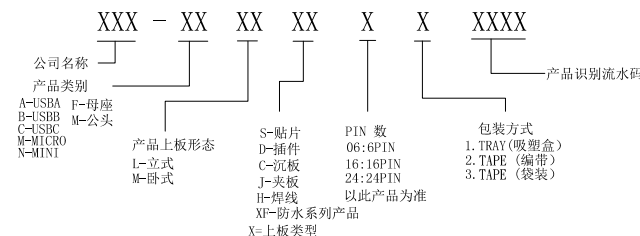

A1	GND	B12	GND
A4	VBUS	B9	VBUS
A5	CC1	B8	SBU2
A6	DP1	B7	DN2
A7	DN1	B6	DP2
A8	SBU1	B5	CC2
A9	VBUS	B4	VBUS
A12	GND	B1	GND
PIN	SIGNAL NAME	PIN	SIGNAL NAME

ZDX 深圳市兆达鑫科技有限公司
Shenzhen zhaodaxin Technology Co., Ltd

TITLE: TYPE- 16P母座 沉板1.1 四脚插板 L=7.96		PART NO.: ZDX-CFMC1620040		
工程图		TEL: 0755-29888153		
THIRD ANGLE PROJECTION		WEB: http://www.szdzjnkj.com/		
UNIT: mm	SCALE: 1:1	SIZE: A4	SHEET: 1/2	