

SPECIFICATIONS:

1. ELECTRICAL CHARACTERISTICS:
 - 1-1. CONTACT RESISTANCE: 30m Ω MAX.
 - 1-2. DIELECTRIC WITHSTANDING VOLTAGE: 100V AC FOR ONE MINUTE.
 - 1-3. INSULATION RESISTANCE: 100MΩ MIN. MEASURED BY 500 VDC
2. MECHANICAL CHARACTERISTICS:
 - 2-1. INSERTION FORCE :5-20N(REF.)
 - 2-2. WITHDRAWAL FORCE :5-20N(REF.)
3. LIFE TEST: 10,000 CYCLES.
4. TO CONFORM TO THE KRCONN HAZARDOUS SUBSTANCE FREE SPEC.
 - 4-1. CURRENT RATING:7.0A

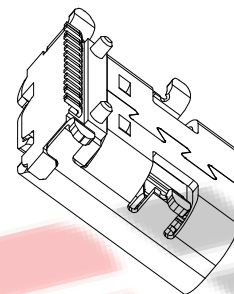

料号编码:

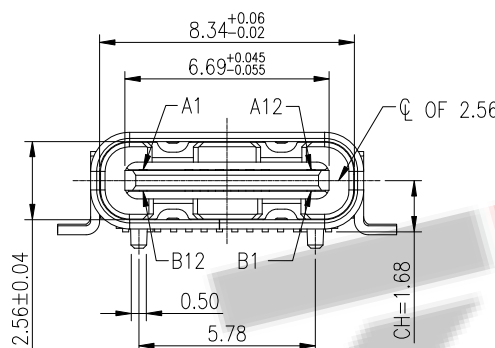
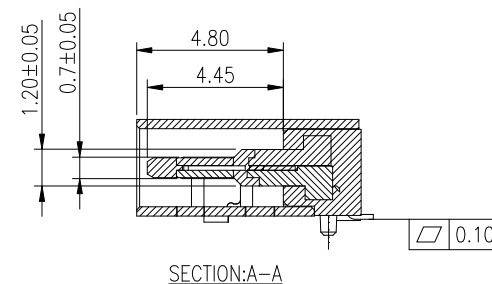
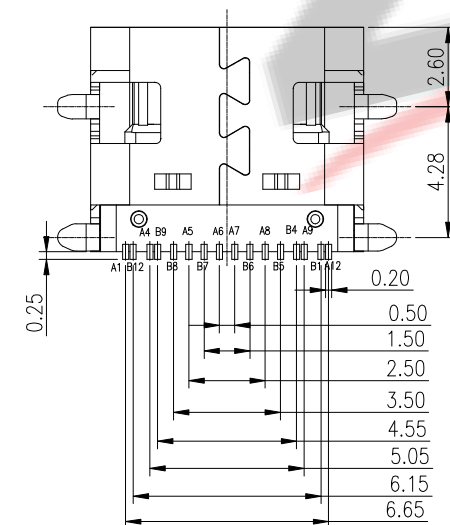
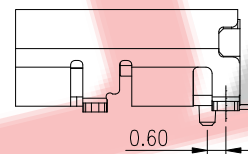
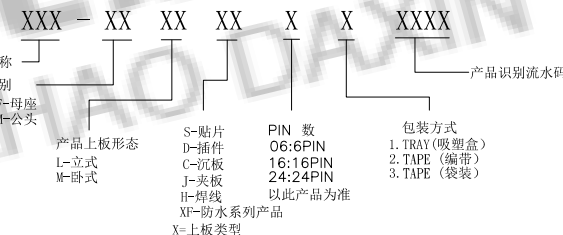

4	MID PLATE	SUS301	N/A	1
3	SHELL	SUS304 1/2H T=0.3	镀镍30u" MIN	1
2	HOUSING	LCP	UL94V-0, 橙色	三次MODING
1	TERMINAL	C18400 T=0.15MM	Contact area:30u"min Au over 40u"Ni min	上下二排端子
ITEM	NAME	MATERIAL	FINISHED	Q'TY

ZDX 深圳市兆达鑫科技有限公司
Shenzhen zhaodaxin Technology Co., Ltd

TITLE:		PART NO.: ZDX-CFMS1620045		
TYPE-C16P母座板上全贴片L7.35		TEL: 0755-29888153		
工程图		WEB: http://www.szzdjmkj.com/		
THIRD ANGLE PROJECTION	UNIT:	SCALE:	SIZE:	SHEET:
	mm	1:1	A4	1/2

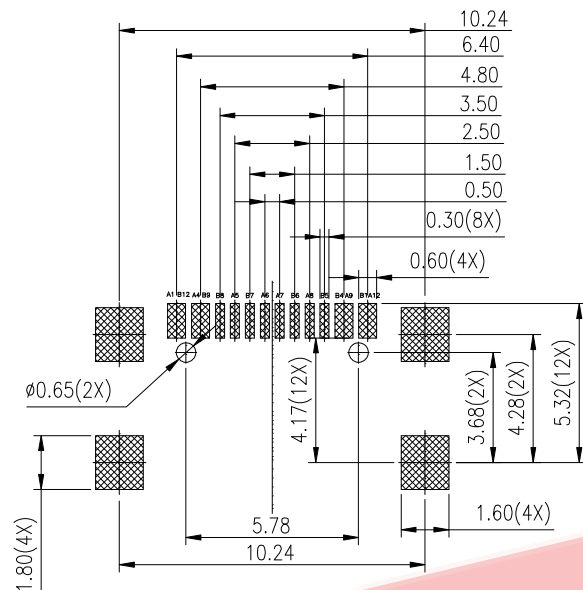

RECOMMENDED PCB LAYOUT(TOP VIEW)
THICKNESS 0.80MM;DEFAULT TOLERANCE:±0.05

USB TYPE-C PIN ASSIGNMENTS

PIN NUMBER	SIGNAL NAME	PIN NUMBER	SIGNAL NAME
A1	GND	B12	GND
A4	VBUS	B9	VBUS
A5	CC1	B8	SBU2
A6	Dp1	B7	Dn2
A7	Dn1	B6	Dp2
A8	SBU1	B5	CC2
A9	VBUS	B4	VBUS
A12	GND	B1	GND

NOTE:

- MATERIAL SPECIFICATION:
 - HOUSING:HIGH TEMPERATURE RESISTANT PLASTIC, LCP 橙色 UL94 V-0.
 - CONTACTS:C18400
 - MID PLATE: STAINLESS STEEL SUS301
 - FRONT SHELL: STAINLESS STEEL SUS304
- PLATING SPECIFICATION:
 - CONTACTS:
Ni 40u" MIN. UNDER PLATED OVER ALL.
Au 30u"PLATED ON THE FUNCTIONAL AREA OF CONTACT.
PLATING SPECIFICATIONS OF THE SOLDER AREA FOLLOW
 - FRONT SHELL:
Ni 30u" MIN. UNDER PLATED OVER ALL.
 - SHIELD PLATE&EMI PLATE:
CLEAR ONLY
- ELECTRICAL PERFORMANCE,
 - LLCR:
VBUS & GND PINS AND OTHER PINS: 40mΩ/PIN MAX.
SHIELD: 50mΩ/MAX.
LLCR MAX. CHANGE OF ALL PINS: 10mΩ.
 - INSULATION RESISTANCE: 100MΩ MIN
 - DIELECTRIC WITHSTAND VOLTAGE,AC 100V FOR 1 MINUTE.
- ENVIRONMENTAL PERFORMANCE:
OPERATING TEMPERATURE: -25°C~+85°C.
- IR REFLOW:
THE PEAK TEMPERATURE ON THE BOARD SHALL BE MAINTAINED FOR 10 SECONDS AT 260°C.

ZDX 深圳市兆达鑫科技有限公司
Shenzhen zhaodaxin Technology Co., Ltd

TITLE: TYPE-C16P母座板上全贴片L7.35 PART NO.: ZDX-CFMS1620045

TEL: 0755-29888153

工程图

WEB: <http://www.szzdjmj.com/>

THIRD ANGLE PROJECTION

UNIT:

SCALE:

SIZE:

SHEET:

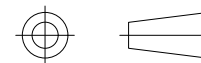

mm

1:1

A4

1/2