

A1	GND	B12	GND
A4	VBUS	B9	VBUS
A5	CC1	B8	SBU2
A6	D+	B7	D-
A7	D-	B6	D+
A8	SBU1	B5	CC2
A9	VBUS	B4	VBUS
A12	GND	B1	GND
PIN	SIGNAL NAME	PIN	SIGNAL NAME

特性:

- 一、电气性能: ELECTRICAL
 1. 额定电流: 5.0A
 2. 接触阻抗: 40 MILLIOHMS MAX
 3. 耐电压: 150V AC / 1 mA MAX
 4. 绝缘阻抗: 150V DC/100 MEGA OHMS MIN
- 二、机械性能:
 1. 插入力: 5~20N
 2. 拔出力: 8~20N
 3. 使用寿命: 10000次、拔出力 5N MIN
- 三、材料: MATERIAL
 1. 塑胶: LCP/PA9T UL94V-0
 2. 端子: C7025/C1814 T=0.15MM
 3. 外壳: SUS304 T=0.30MM
 4. 卡勾: SUS304 T=0.20MM
- 四、电镀: FINISH
 1. 端子: 接触点镀金30~MIN
PIN脚焊接区域镀金10~MIN.
 2. 外壳: 镀镍50~MIN (盐雾48H)
- 五、电镀品需做粘锡测试: 粘锡面积达到95%以上.
- 六、SMT回流焊 (峰值260° C±5° C) 不能起泡、熔胶、变色不良 (变形在公差范围以内)
- 七、工作温度: -55° C~+85° C
- 八、盐雾测试: 通过48H在浓度为5±1%盐水的盐雾测试无生锈现象
- 九、□代表参考尺寸

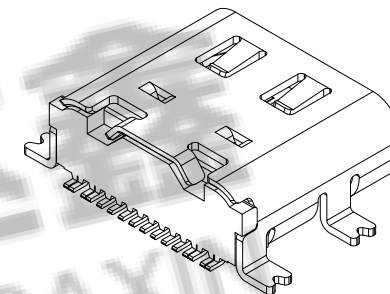

料号编码:

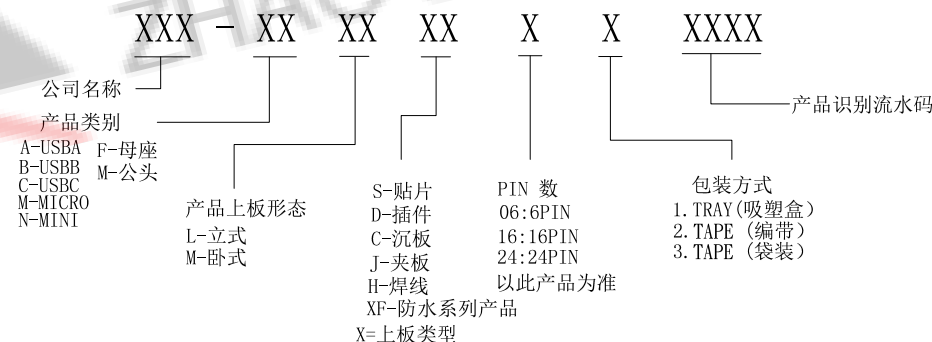

ZDX 深圳市兆达鑫科技有限公司
Shenzhen zhaodaxin Technology Co., Ltd

TITLE: TYPE-C 16PIN板上四脚贴片SMT母座 长 L=7.35MM 带弹 工程图

PART NO.: ZDX-CFMS162JS24

TEL: 0755-29888153

WEB: <https://szzhaodaxin.com/>

THIRD ANGLE PROJECTION	UNIT:	SCALE:	SIZE:	SHEET:
	mm	1:1	A4	1/2

RoHS Compliant

Halogen Free

customer drawing

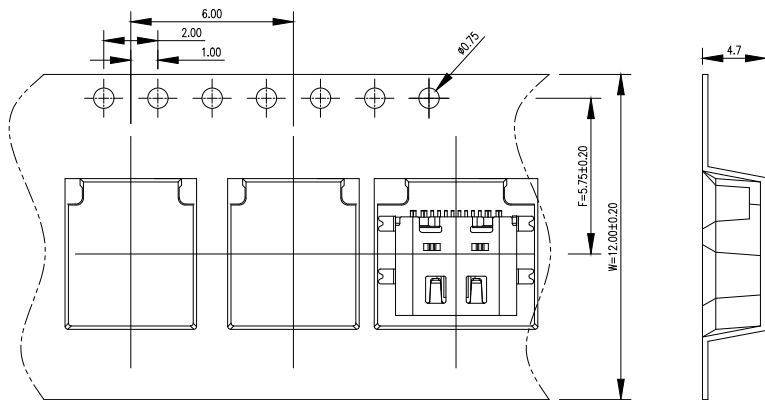

① 产品入载带示意图

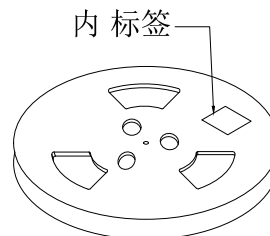

② 卷盘贴标签示意图

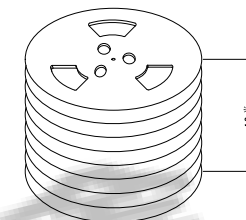

③ 10盘产品叠层示意图

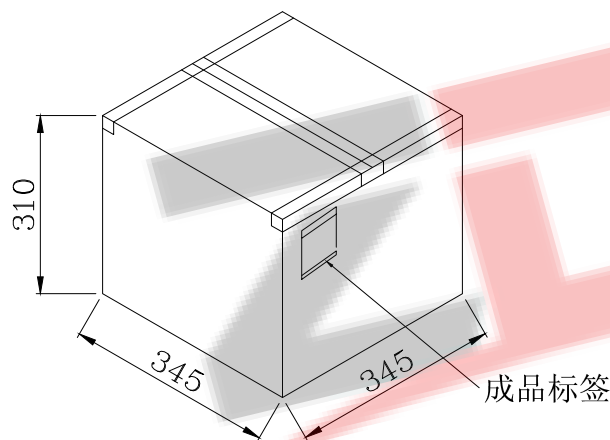

⑤ 外箱封箱示意图

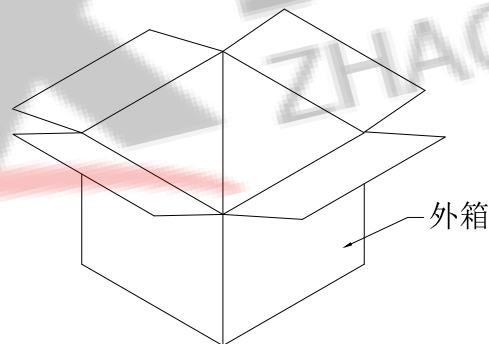

④ 产品入外箱示意图

包装说明:

1. 将检验好的成品;对插口朝前放入载带;每卷装1000PCS产品;具体如图一所示
2. 将包装好的产品;每盘必需贴上内标签;具体如图二所示
3. 将贴好内标签的产品每10盘叠;具体如图三所示
5. 装好后并封好纸箱及贴好相关标签;具体如图五所示;
(产品包装的标签,如客户有要求,请按客户要求包装出货)
6. 载带前面留10PCS空格,后面留10PCS空格
7. COVER与CARRY剥离力:50-125g,速度:300mm/分钟左右,剥离角度:165°-180°



深圳市兆达鑫科技有限公司

Shenzhen zhaodaxin Technology Co., Ltd

TITLE:

TYPE-C 16PIN板上四脚贴片SMT母座 长
L=7.35MM 带弹

工程图

PART NO.:ZDX-CFMS162JS24

TEL:0755-29888153

WEB: <https://szzhaodaxin.com/>

THIRD ANGLE PROJECTION

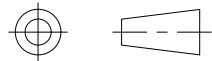

UNIT:

mm

SCALE:

1:1

SIZE:

A4

SHEET:

2/2