

料号编码:

XXX - XX XX XX X X XXXX

公司名称 | 产品类别 | 产品上板形态 | S-贴片 | PIN 数 | 包装方式

A-USBA F-母座 | B-USBB M-公头 | L-立式 | D-插件 | 06:6PIN | 1. TRAY (吸塑盒)

C-USBC | M-MICRO | M-卧式 | C-沉板 | 16:16PIN | 2. TAPE (编带)

N-MINI | H-焊线 | 24:24PIN | 3. TAPE (袋装)

X=上板类型

- SPECIFICATION:
- ELECTRICAL:
 - 1.1 CURRENT RATING:5A;
 - 1.2 CONTACT RESISTANCE:40mΩ Max;
 - 1.3 DIELECTRIC WITHSTANDING VOLTAGE:150V AC;
 - 1.4 INSULATION RESISTANCE:150V DC/100 MΩ MIN;
 - MECHANICAL:
 - 2.1 MATING FORCE:5~20N;
 - 2.2 UNMATING FORCE:8~20N;
 - 2.3 DURABILITY:10000 CYCLES;6~20N AFTER DURABILITY TEST;
 - MATERIAL:
 - 3.1 HOUSING&MOLDING:LCP UL94V-0;
 - 3.2 TERMINAL:C18400 T=0.12mm;
 - 3.3 SHELL:SUS304 T=0.30mm;
 - 3.4 MID PLATE:SUS304 T=0.15mm;
 - PLATING SPECIFICATION:
 - 4.1 TERMINAL:CONTACT POINT GOLD PLATED 3u" MIN PIN WELDING AREA GOLD PLATED 3u" MIN.
 - 4.2 SHELL:PLATED Ni 60u" MIN(Salt spray 48H)
 - ELECTROPLATED PRODUCTS NEED TO UNDERGO TIN ADHESION TESTING: THE TIN ADHESION AREA SHOULD REACH OVER 95%.
 - SMT REFLOW SOLDERING (PEAK VALUE 260 °C ± 5 ° C) SHALL BE FREE OF BLISTERING, GLUE MELTING AND POOR COLOR CHANGE (DEFORMATION WITHIN TOLERANCE)
 - OPERATING TEMPERATURE: -40°C~+85°C

PIN	SIGNAL NAME	PIN	SIGNAL NAME
A1	GND	B12	GND
A2	TX1+	B11	RX1+
A3	TX1-	B10	RX1-
A4	VBUS	B9	VBUS
A5	CC1	B8	SBU2
A6	D+	B7	Dn2
A7	D-	B6	Dp2
A8	SBU1	B5	CC2
A9	VBUS	B4	VBUS
A10	TX2-	B3	TX2-
A11	TX2+	B2	TX2+
A12	GND	B1	GND

ZDX 深圳市兆达鑫科技有限公司
Shenzhen zhaodaxin Technology Co., Ltd

TITLE: TYPE-C 24P母座 立贴SMT 外壳带弹 H=14.5 A款 黑色LCP 端子C18400 3u" 外壳SUS304

PART NO.: ZDX-CFLS242JS10

TEL: 0755-29888153

WEB: <https://szzhaodaxin.com/>

工程图

THIRD ANGLE PROJECTION

UNIT:	SCALE:	SIZE:	SHEET:
mm	1:1	A4	1/2

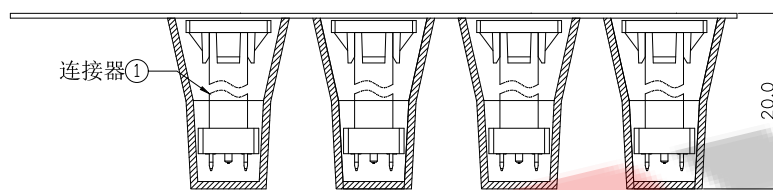
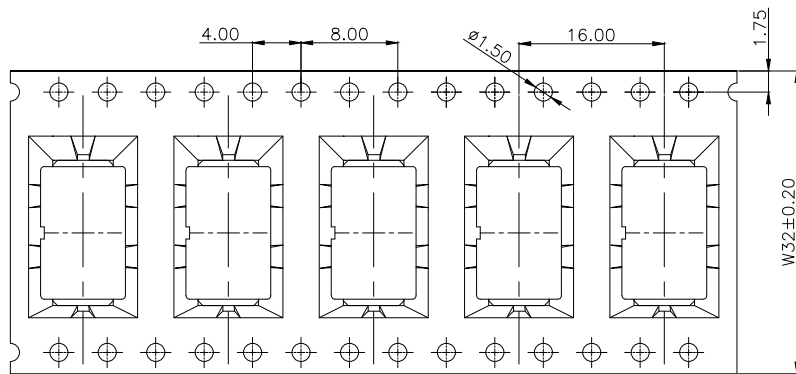

产品入载带示意图

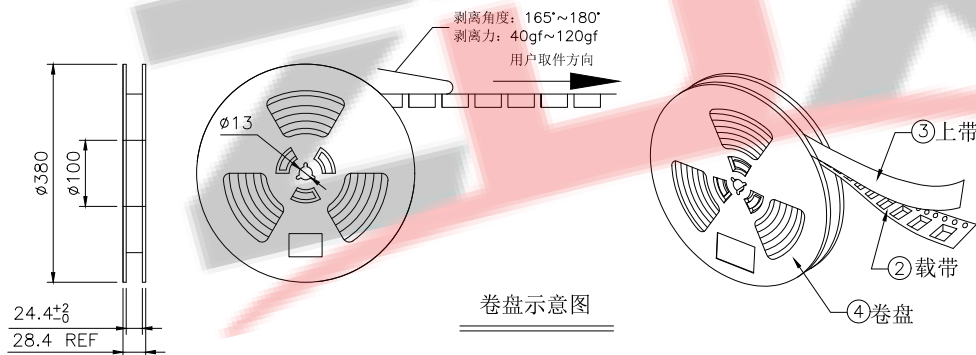

卷盘示意图

包装示意图

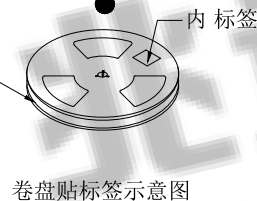
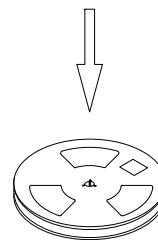

卷盘贴标签示意图

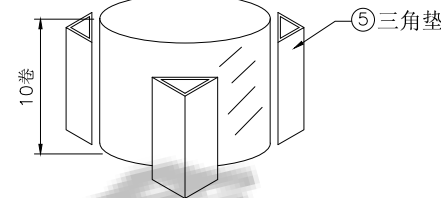

10盘产品叠层示意图

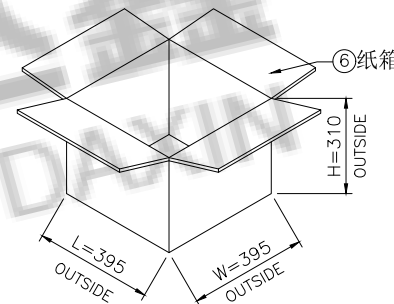

技术要求:

1. 载带首尾各留出12PCS空格不装产品;
2. 每穴放置1PCS产品, 每卷装300PCS产品, 放置方式如图所示;
3. 将包装好的产品;每盘必需贴上内标签;将贴好内标签的产品每8盘堆叠.
4. 在纸箱四角垫上4个三角垫, 然后把装好产品的卷盘放入纸箱中, 最后用胶带封箱; (如客户有要求, 请按客户要求包装出货)
5. 上带与载带的剥离力: 40gf~120gf, 跳动量在30gf内; (剥离角度: 165°~180°, 剥离速度: 250~300mm/min)
6. 产品符合RoHS环保标准要求.

06	纸箱	B-05-0012	395mm*395mm*310mm	1 PCS
05	三角垫	/	300mm*260mm*7mm	4 PCS
04	卷盘	B-02-0001	D=380mm, d=100mm, H=28.5mm	8 PCS
03	上带	B-04-0001	W=25.5mm, T=0.05mm	5184 mm
02	载带	B-03-0018	W=32mm, T=0.50mm, P=16.0mm	5184 mm
01	连接器	ZDX-CFLS242JS10	24PIN, SMT	2400 PCS
序号	物料名称	物料编号	规格	描述

ZDX 深圳市兆达鑫科技有限公司
Shenzhen zhaodaxin Technology Co., Ltd

TITLE:		PART NO.:ZDX-CFLS242JS10		
TYPE-C 24P母座 立贴 H=14.50 A款 包装规范 工程图		TEL:0755-29888153		
		WEB: https://szzhaodaxin.com/		
THIRD ANGLE PROJECTION	UNIT:	SCALE:	SIZE:	SHEET:
	mm	1:1	A4	2/2